

T3 LED RGB Controller



FC CE RoHS COMPLIANT (warranty 3 years)

T3 is the newly upgraded RGB touch controller which adopts the most advanced 2.4GHZ RF wireless transmission technology. The control system consists of two parts, the RF remote control and receiver, realize the signal synchronization on unlimited receivers within effective distance .built-in with 32 changing modes, adopt the advanced PWM (pulse width modulation) control technology, smooth changing effect and no flicker on the led light. Unique full-color circle touch control technology, 8 touch keys on the receiver, you can select the functions of switch, pause, changing modes, speed and LED brightness, all functions can be achieved by remote controller, controller can automatically adapt to the input voltage of DC 12V-24V. the controller is designed with 4 wires 3 loops output, widely used for all LED lights with current-limiting resistance, such as RGB LED module, LED tape and SMD flexible strip and so on.

1. Technical Specs

Remote Control

- Model: T3
- Input voltage: DC5V built-in Lithium battery
- Working current: <30mA
- Working frequency: 2.4GHZ
- RF remote distance: 30m
- transmitting rate: 500Kbps
- Battery capacity: 1000mAh
- Standby time:1 year
- Normal using time: 30 days
- Charge time: <4 hours
- Number of Charge cycles: 500 times
- Dimensions: L145×W55×H22(mm)
- Package Size: L165×W76.5×H55(mm)
- Weight (G.W): 200g

Controller

- Power supply chosen: DC CV SMPS
- Model: T3-5A
- Input voltage: DC12V~DC24V
- Max current load: 5A x 3CH Max 15A
- Max output power: 180W/360W(12V/24V)
- Change mode: 32 Fantastic modes
- Control button: 8 touch buttons
- Grey scale levels: 1024x1024x1024
- Unlimited sync quantity: no quantity limit
- Working temperature: -30℃~55℃
- Dimensions: L211×W40×H30(mm)
- Package Size: L215×W43×H33(mm)
- Weight (G.W): 180g

2. Performance Features

3. Product size

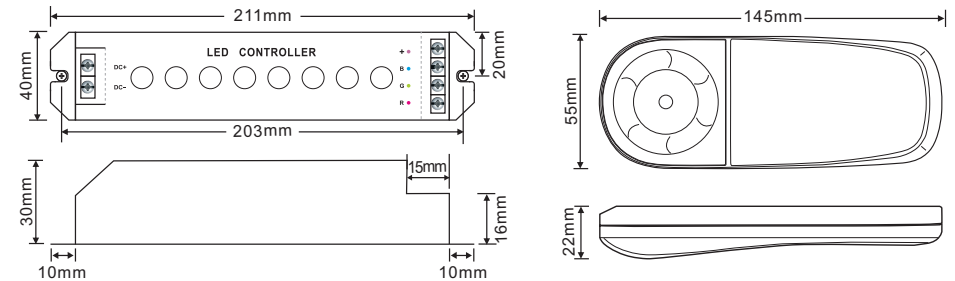

4. Operation panel and component instruction:

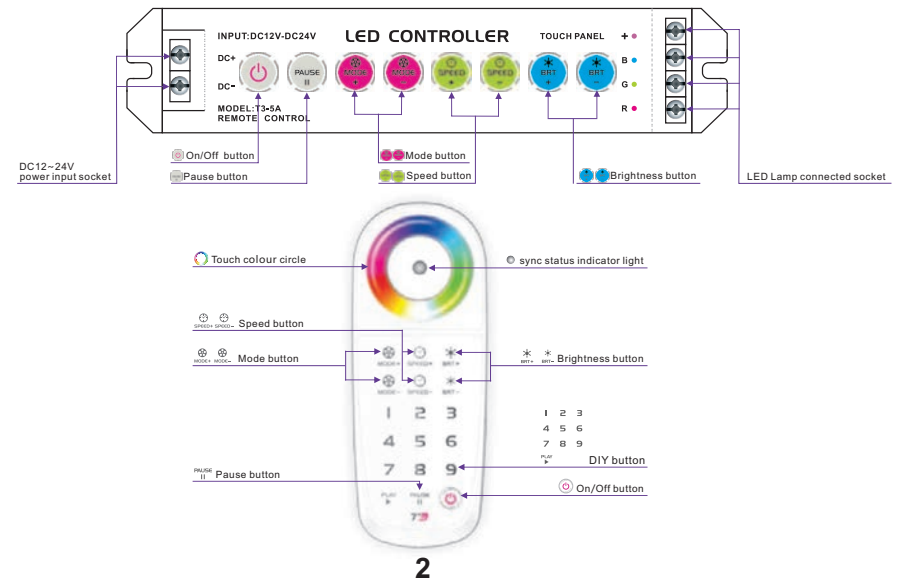

5. The charging methods for remote control

1. When charging, please connect USB cable to the mobile charger or computer with the USB interface.
2. The blue indicator light flickers while charging, and turns green means the charging is completed.
3. No memory effect in the lithium battery of remote control. Follow the standard charging procedure even for the first three times, no need over charge.
4. Red indicator light flickers meaning low battery and need to be charged. charging in low battery will affect life of battery.
5. Please make sure a 40% battery on the remote control for stored if it's not use for long period of time, and it needs to be charged at least every half year ,otherwise the capacity of the battery would be decreased or the battery gets damaged.

6. Detailed key functions











The remote control has 18 function buttons and 1 full-color touch circle; The controller has 8 touch buttons.

The learning of remote control:

Learning ID: Press the key "ON/OFF" on the receiver for 3 seconds until there is a buzzer sound, means entering into the ID learning state, press any key on the remote control, until the LED indicator light flashes in green color, meanwhile the buzzer on the receiver sounds, the controlling between remote control and receiver is activated, release the button when the learning is finished. (the whole process should be done in 5 seconds).

 If you want to control multiple receivers synchronously, just follow the above instructions for each receiver.

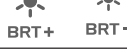
Cancelling ID: Press the key " ON/OFF" on the receiver for over 5 seconds, then press any key on the remote control until the LED indicator light flashes in red color, meanwhile the buzzer sounds, means the controlling between remote control and receiver is cancelled.

Controller sign	Remote control sign	Button	Description
		ON/OFF	• Turn on/off the Controller (Turn on/off the LED light) .
	PAUSE II	PAUSE	• Short press it to stay at current color. • Short press it again, it will continue to change. • Press this button in 3 seconds, the buzzer can be on or off.
		MODE+ MODE-	• Short press these two keys to select next mode or previous mode.
		SPEED+ SPEED-	• press these two keys to speed up and speed down.
		BRT+ BRT-	• Press the keys to increase or decrease brightness , • Keep pressing to adjust brightness continuously
		Full-Color Touch circle	• When touching the full-color circle, LED lights will show the same color as the circle.
		9 DIY keys	• Short press DIY key to load out the stored DIY modes • Press the keys for 3 seconds, the controller will save the present function mode automatically, which can save 9 modes and save repeatedly as well. • Press "PLAY" key to play cycle modes (merely play the dynamic effects, the static effect will be skipped automatically).

3

7. Tables of Changing mode

No.	Mode	Description	No.	Mode	Description
1	Static red	brightness adjustable	17	Cyan fade out and fade in	speed/brightness adjustable
2	Static green	brightness adjustable	18	White fade out and fade in	speed/brightness adjustable
3	Static blue	brightness adjustable	19	RGB fade out and fade in	speed/brightness adjustable
4	Static yellow	brightness adjustable	20	Red Green color smooth	speed/brightness adjustable
5	Static purple	brightness adjustable	21	Red Blue color smooth	speed/brightness adjustable
6	Static cyan	brightness adjustable	22	Green Blue color smooth	speed/brightness adjustable
7	Static white	brightness adjustable	23	Red Yellow color smooth	speed/brightness adjustable
8	RGB skipping	speed/brightness adjustable	24	Green Cyan color smooth	speed/brightness adjustable
9	7 colors skipping	speed/brightness adjustable	25	Blue purple color smooth	speed/brightness adjustable
10	White strobe	speed/brightness adjustable	26	Green Yellow color smooth	speed/brightness adjustable
11	7 colors strobe	speed/brightness adjustable	27	Blue Cyan color smooth	speed/brightness adjustable
12	Red fade out and fade in	speed/brightness adjustable	28	Red Purple color smooth	speed/brightness adjustable
13	Green fade out and fade in	speed/brightness adjustable	29	Blue White color smooth	speed/brightness adjustable
14	Blue Fade out and fade in	speed/brightness adjustable	30	Yellow Purple Cyan color smooth	speed/brightness adjustable
15	Yellow fade out and fade in	speed/brightness adjustable	31	RGB color smooth	speed/brightness adjustable
16	Purple fade out and fade in	speed/brightness adjustable	32	Full-color smooth	speed/brightness adjustable

8. System Diagram:

 Unlimited receivers can be installed within effective distance, no wiring needed between the receivers, which can be less or more in quantity according to your need for the installation, if you want to increase or decrease the receivers, just activate or cancel the control ID on the remote controller will be fine, no any changes and affects on other receivers.

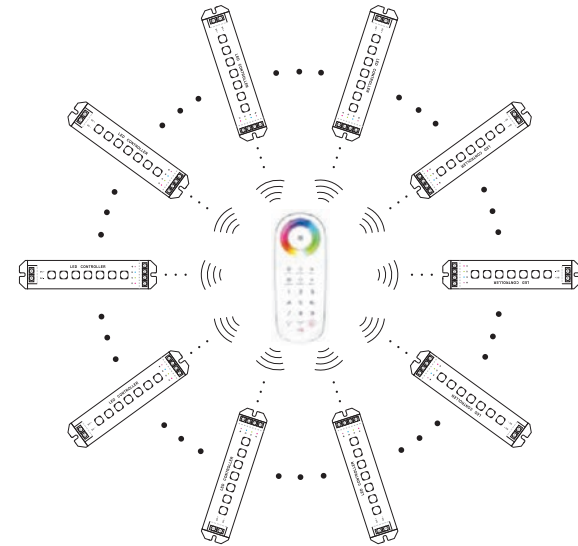

4

9. Wiring diagram

1. Multiple controller are powered by one power supply :

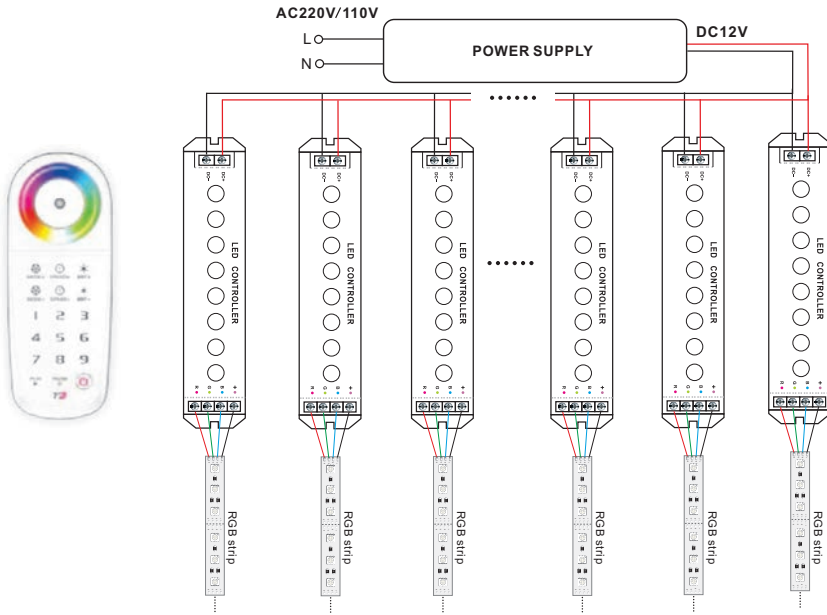

2. Per controller are powered by one power supply independently :

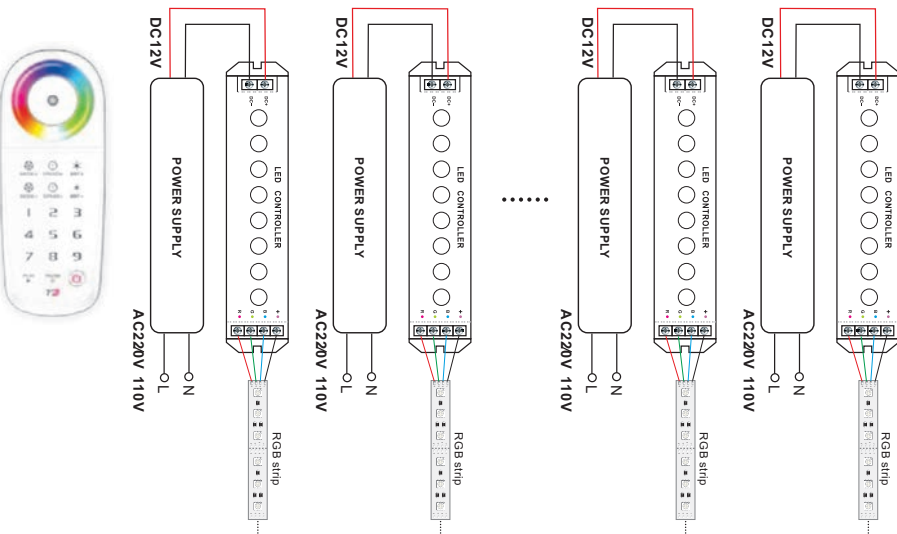

5

10. Attention

1. The product shall be installed and serviced by a qualified person.
2. This product is non-waterproof. Please avoid the sun and rain. When installed outdoors please ensure it is mounted in a water proof enclosure.
3. Good heat dissipation will prolong the working life of the controller. Please ensure good ventilation.
4. Please check if the output voltage of any LED power supplies used comply with the working voltage of the product.
5. Please ensure that adequate sized cable is used from the controller to the LED lights to carry the current. Please also ensure that the cable is secured tightly in the connector to avoid the accidents due to overheat and poor contact on the wire.
6. Ensure all wire connections and polarities are correct before applying power to avoid any damages to the LED lights.
7. If a fault occurs please return the product to your supplier. Do not attempt to fix this product by yourself.

11. Warranty Agreement

1. We provide lifelong technical assistance with this product:
 - A 3 year warranty is given from the date of purchase. The warranty is for free repair or replacement and covers manufacturing faults only.
 - For faults beyond the 3 year warranty we reserve the right to charge for time and parts.
2. Warranty exclusions below:
 - Any man-made damages caused from improper operation, or connecting to excess voltage and overloading.
 - The product appears to have excessive physical damage.
 - Damage due to natural disasters and force majeure.
 - Warranty label, fragile label and unique barcode label have been damaged.
 - The product has been replaced by a brand new product.
3. Repair or replacement as provided under this warranty is the exclusive remedy to the customer. LT shall not be liable for any incidental or consequential damages for breach of any stipulation in this warranty.
4. Any amendment or adjustment to this warranty must be approved in writing by Ltech only.

★ This manual only applies to this model. LT reserves the right to make changes without prior notice.

6