

LED Intelligent Driver

- Dimming interface: 0-10V (1-10V/10VPWM/RX).
- T-PWM™ digital dimming, present a perfect visual experience.
- With soft-on and fade in function, visual more comfortable.
- Automatic recognition of 0-10V, 1-10V input signal.
- DIP switch for multiple optional currents' quick selection.
- Dimming range: 0-100%, LED start at 0.01% possible.
- 0-100% flicker-free, High frequency exemption level.
- Ultra-low consumption of 0-10V ports: < 0.05mA.
- Innovative thermal management technology, intelligent power life protection.
- Over-heat / Over load / Short circuit protection, recover automatically.
- Suitable for internal lights application for I/II/III.
- Up to 50000-hour life time.
- 5 years warranty (Rubycon capacitor).

T-PWM™
Super depth dimming technology

Flicker-free
IEEE 1789

Dimmable:
0.01-100%

TUV Certificate No. B 001119 0007 Rev. 00
 CB Certificate No. SG PSB-LE-01925
 RCM Certificate No. RCMP19279 001
 CE EMC Certificate No. BSTXD190412501201EC
 LVD Certificate No. BST190412501201SC
 CCC Certificate No. 2019011002209509

4 in 1 dimming
 0-10V
 1-10V
 PWM
 RX



Specification

Model		SE-10-350-700-W1A	SE-12-100-400-W1A	SE-12-350-700-W1A
OUTPUT	Output Voltage	2-12Vdc	10-42Vdc	10-24Vdc
	Max Output Voltage	20Vdc	50Vdc	35Vdc
	Output Current	350-700mA	100-400mA	350-700mA
	Output Power Range	0.7W-8.4W	1W-12W	3.5W-12W
	Strobe Level	No video flicker / High frequency exemption assessment level.		
	Dimming Range	0-100%, 0.01% dimming depth.		
	LF current ripple(<120Hz)	<1%		
	Current Accuracy	±5%		
	Ripple & Noise	≤2V		
	PWM Dimming Frequency	≤3600Hz		
INPUT	Dimming Interface	0-10V (1-10V/10VPWM/RX) 0-10V Interface consumption: <0.05mA		
	Input Voltage	100-240Vac		
	Frequency	50/60Hz		
	Input Current	0.15A@115Vac, 0.1A@230Vac	0.25A@115Vac, 0.15A@230Vac	
	Power Factor	PF>0.95/115Vac, PF>0.8/230Vac, at full load		PF>0.97/115Vac, PF>0.85/230Vac, at full load
	Efficiency	75%	82%	81%
	Inrush Current(typ.)	Cold start 5A at 230Vac		
	Anti Surge	L-N: 1kV		
	Leakage Current	<0.35mA/230Vac	<0.5mA/230Vac	
ENVIRONMENT	Working Temperature	ta: -30°C ~ 50°C tc: 75°C		
	Working Humidity	20 ~ 95%RH, non-condensing		
	Storage Temp., Humidity	-40°C ~ 80°C, 10~95%RH		
	Temp. Coefficient	±0.03%/°C (0-50°C)		
	Vibration	10-500Hz, 2G 12min./1cycle, period for 72min. each along X, Y, Z axes.		
PROTECTION	Over-heat Protection	Intelligently adjusting or turning off the output current if the PCB temperature ≥110°C, auto recovers.		
	Over Load Protection	Shut down the output when current load ≥102%, auto recovers.		
	Short Circuit Protection	Shut down automatically if short circuit occurs, auto recovers.		
SAFETY & EMC	Withstand Voltage	I/P-O/P: 3750Vac		
	Isolation Resistance	I/P-O/P: 100MΩ/500VDC/25°C/70%RH		
	Safety Standards	IEC/EN61347-1, IEC/EN61347-2-13		
	EMC Emission	EN55015, EN61000-3-2 Class C, IEC61000-3-3		
	EMC Immunity	EN61000-4-2,3,4,5,6,8,11 EN61547		
	Strobe Test Standard	IEEE 1789		
OTHERS	Dimension	135×30×20mm(L×W×H)		
	Packing	140×34×23mm(L×W×H)		
	Weight(G.W.)	80g±10g		

LED current selection

DIP switch for multi optional currents' quick selection
(see the table below).

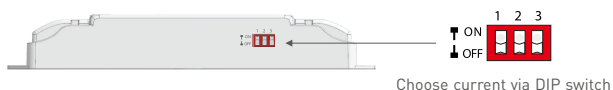

SE-10-350-700-W1A	DIP Switch										 ON OFF
	Output Current	350mA	400mA	450mA	500mA	550mA	600mA	650mA	700mA		
	Output Voltage	2-12V	2-12V	2-12V	2-12V	2-12V	2-12V	2-12V	2-12V		
	Output Power	0.7-4.2W	0.8-4.8W	0.9-5.4W	1-6W	1.1-6.6W	1.2-7.2W	1.3-7.8W	1.4-8.4W		

SE-12-100-400-W1A	DIP Switch									 ON OFF
	Output Current	100mA	150mA	200mA	250mA	300mA	350mA	400mA		
	Output Voltage	10-42V	10-42V	10-42V	10-42V	10-40V	10-34V	10-30V		
	Output Power	1-4.2W	1.5-6.3W	2-8.4W	2.5-10.5W	3-12W	3.5-12W	4-12W		

SE-12-350-700-W1A	DIP Switch									 ON OFF
	Output Current	350mA	400mA	450mA	500mA	550mA	600mA	650mA	700mA	
	Output Voltage	10-24V	10-24V	10-24V	10-24V	10-22V	10-20V	10-18.5V	10-17V	
	Output Power	3.5-8.4W	4-9.6W	4.5-10.8W	5-12W	5.5-12.1W	6-12W	6.5-12W	7-12W	

* Please choose the current value when the driver is power off.

Dimensions

Unit : mm

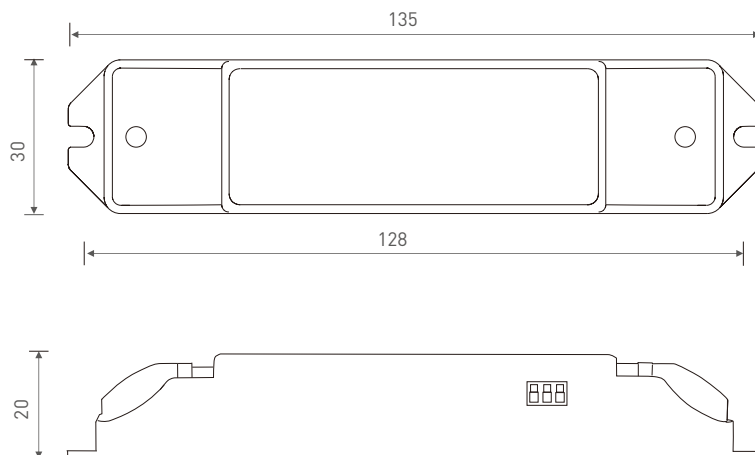

Wiring diagram

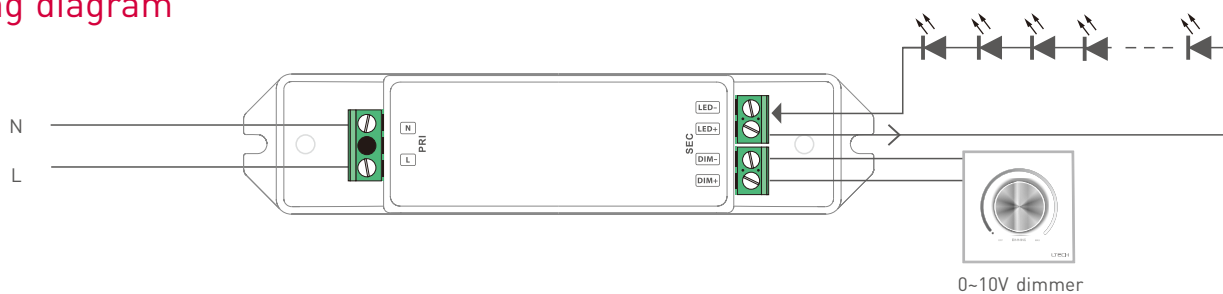

Relationship Diagrams

SE-10-350-700-W1A

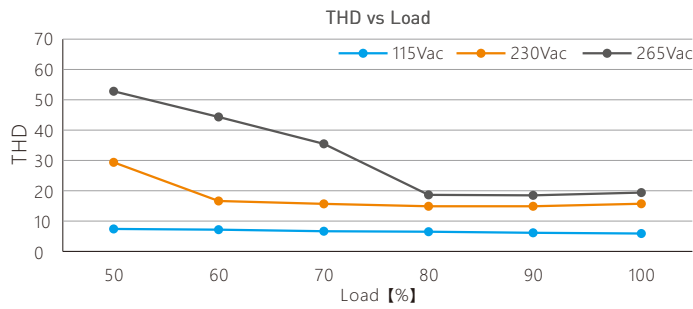
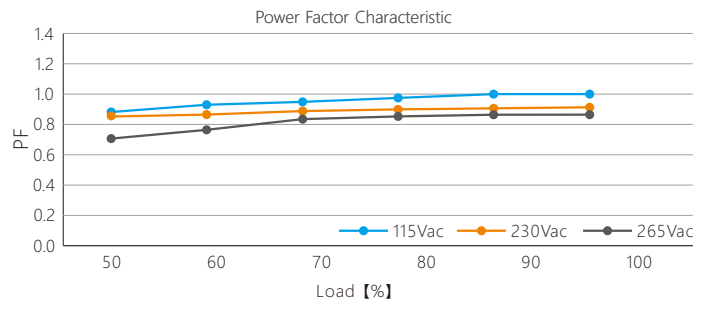
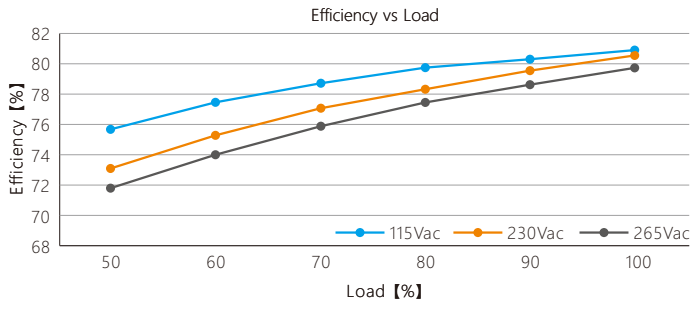

SE-12-100-400-W1A

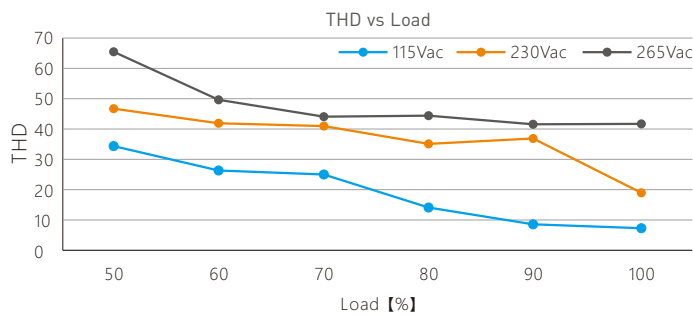
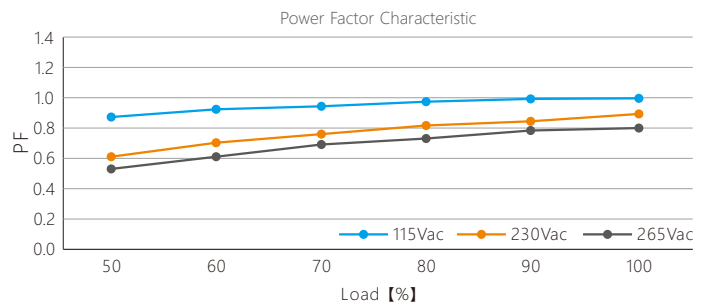
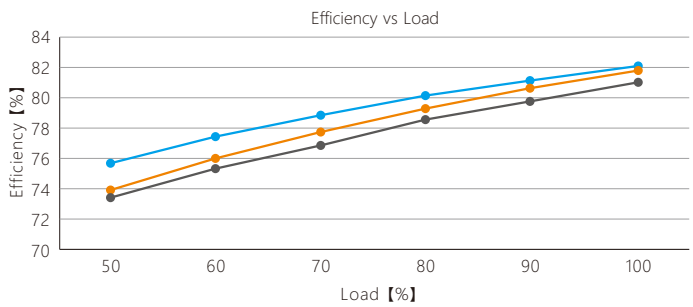

SE-12-350-700-W1A

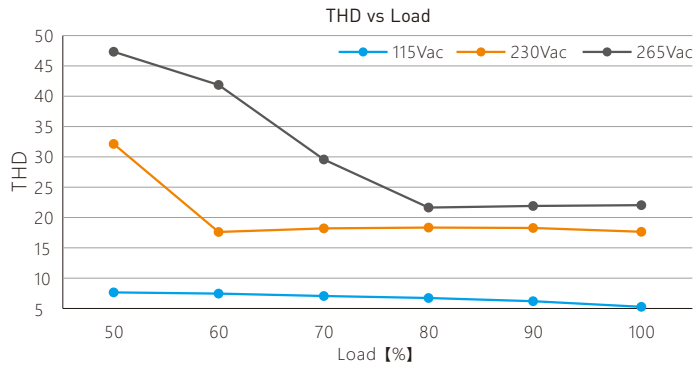
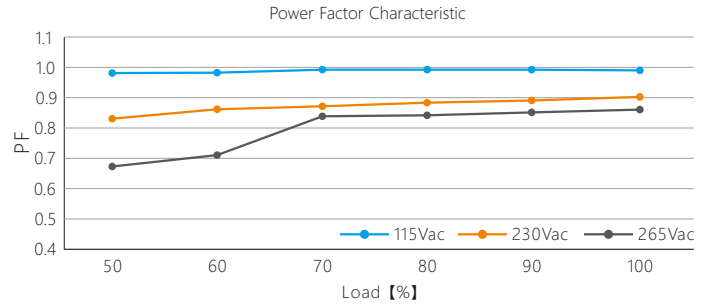
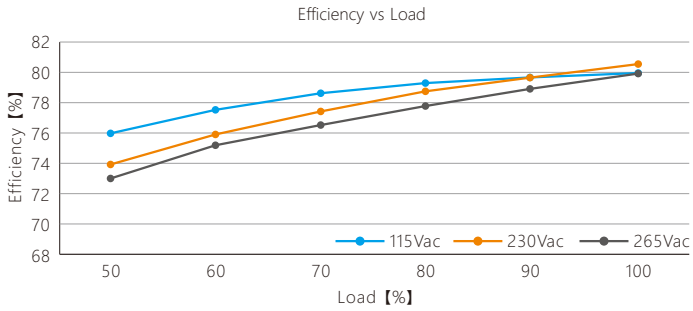

Flicker Test Form

