

Intelligent Full Color RGBW LED Driver (Constant Voltage)

- Small size and light weight. The housing is made from V0 flame retardant PC materials that SAMSUNG/COVESTRO uses.
- The clamshell design and screwless type for strain-relief. The design of dismountable end cap allows you to adjust the length of housing depending on your needs.
- With soft-on and fade-in dimming function, enhancing your visual comfort.
- Dimming from 0~100%, down to 0.1%.
- Dimming interface: DMX512/RDM, DALI-2 DT6/DT8, Push DIM/RGB.
- Energy-efficient driver: Efficiency 93%, PF>0.98, THD<6%.
- Comply with the EU's ErP Directive, stand-by power consumption<0.5W.
- The secure and reliable design for signal isolation.
- Innovative thermal management technology intelligently protects the life of the LED driver.
- Overheat, overvoltage, overload, short circuit protection and automatic recovery.
- Up to 50,000-hour life time.
- 5-year warranty (Rubycon capacitor).



Flicker-free
IEEE 1789
Achieve the high-frequency exemption level

Dimmable:
0.1%~100%
DIM/RGBW



Technical Specs

Model	LM-150-24-G4K3			
Features	Output Type	Constant Voltage		
	Dimming Interface	DMX12/RDM, DALI-2 DT6/DT8, Push DIM/RGB		
	Output Feature	Isolation		
	Protection Grade	IP20		
	Insulation Grade	Class II (Suitable for class I/ II /III light fixtures)		
OUTPUT	Output Voltage	24Vdc		
	Output Voltage Range	24Vdc ± 0.5Vdc		
	Output Current	Max. 6.25A (1.56Ax4CH)		
	Output Power	Max. 150W		
	Output Power Range	0-150W		
	Strobe Level	High frequency exemption level		
	Dimming Range	0-100%, down to 0.1%		
	Overload Power Limitation	≥102%		
	Ripple	Switch ripple<150mV, noise<300mV		
INPUT	PWM Frequency	3600Hz		
	DC Voltage Range	200-280Vdc		
	AC Voltage Range	198-264Vac		
	Rated Voltage	220-240Vac		
	Frequency	50/60Hz		
	Input Current	≤0.75A/230Vac		
	Power Factor	PF>0.98/230Vac (at full load)		
	THD	THD<6%@230Vac (at full load)		
	Efficiency (typ.)	93%		
	Standby power consumption	<0.5W		
	Inrush Current	Cold start 45A@230Vac (Test twidth=840us tested under 50% Ipeak)		
	Anti Surge	L-N: 2KV		
	Leakage Current	Max. 0.5mA		
ENVIRONMENT	Working Temperature	ta: -20 ~ 50°C tc: 85°C		
	Working Humidity	20 ~ 95%RH, non-condensing		
	Storage Temperature/Humidity	-40 ~ 80°C, 10-95%RH		
	Temperature Coefficient	±0.03%/°C (0-50°C)		
	Vibration	10-500Hz, 2G 12min/1cycle, 72 min for X, Y and Z axes respectively		
PROTECTION	Overheat Protection	Intelligently adjust or turn off the output current if the PCB temperature ≥110°C, and recover automatically		
	Overload Protection	Shut down the output when current load≥102%, and recover automatically		
	Short Circuit Protection	Enter hiccup mode if short circuit occurs, and recover automatically		
	Overvoltage Protection	Shut down the output when non-load voltage≥28V, and recover automatically		
SAFETY & EMC	Withstand Voltage	I/P-O/P: 3750Vac		
	Isolation Resistance	I/P-O/P: 100MΩ/500VDC/25°C/70%RH		
	Safety Standards	CCC	China	GB19510.1, GB19510.14
		TUV	Germany	EN61347-1, EN61347-2-13, EN62493
		CB	CB member states	IEC61347-1, IEC61347-2-13
		CE	European Union	EN61347-1, EN61347-2-13, EN62384, EN61547
		KC	Korea	KC61347-1, KC61347-2-13
		EAC	Russia	IEC61347-1, IEC61347-2-13
		RCM	Australia	AS61347-1, AS61347-2-13
		EMEC	Europe	EN61347-1, EN61347-2-13, EN62384
	EMC Emission	CCC	China	GB/T17743, GB17625.1
		CE	European Union	EN55015, EN61000-3-2, EN61000-3-3, EN61547
		KC	Korea	KN15, KN61547
		EAC	Russia	IEC62493, IEC61547, EH55015
		RCM	Australia	EN55015, EN61000-3-2, EN61000-3-3, EN61547
EMC Immunity		EN61000-4-2,3,4,5,6,8,11, EN61547		
Strobe Test Standard		IEEE 1789		
OTHERS	Life Time			
	Warranty	5 years		

The driver is suitable for connecting resistor current-limiting LED fixture (e.g. LED strip). The inrush current will be dozens of times increased if connecting built-in constant current IC current-limiting LED fixtures, the driver will activate the overloaded protection (hiccup flickering). When you order, please remark controlling the constant current LED fixture (e.g. MR16 lamp, underground light, LED wall washer, constant current LED strip, etc.), so that we can prepare them with special procedures.

Product Size

Unit: mm

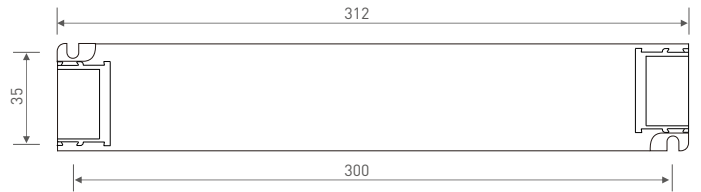
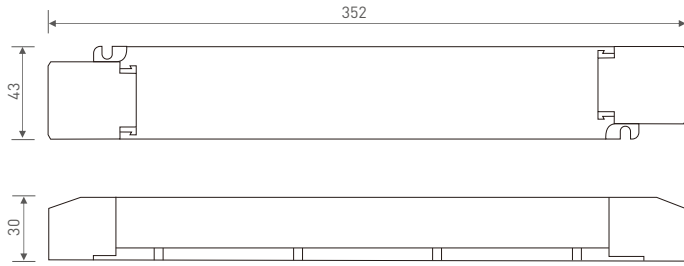

Wiring Diagram

DMX/RDM Connection

Wire diameter: 0.75-1.5" (20-16AWG)
Strip length: 8-9mm

Wire diameter: 1.5-2.5" (14-12AWG)
Strip length: 6-7mm

0-100% dimming range
RGBW color light adjustment

DALI Connection

0-100% dimming range
RGBW color light adjustment

Push DIM/RGB Connection

0-100% dimming range
RGB color light adjustment
Short press to turn on/off
Long press to dim

* Push DIM is invalid under DC voltage input.
* Dimming interface priority: DMX12/RGM first, DALI-2 DT6/DT8, Push DIM/RGB next.

Push DIM/RGB



Reset switch

- On/off control: Short press.
- Stepless dimming: Long press.
- With every other long press, the brightness goes to the opposite direction.
- Dimming memory: Brightness will be the same as previously adjusted when lights are turned on.

Protective Housing Application Diagram

Tension plate

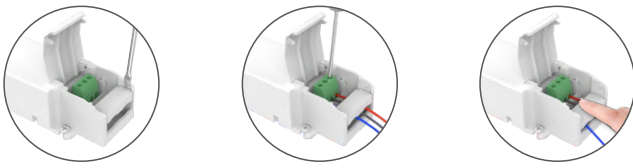

1. Pry up the protecting housing in the side plate position with a tool.
2. Connect to electrical wires with a screwdriver as wiring diagram shows.
3. Press down the tension plate to fix the electrical wires, then close the protective housing.

Remove the protective housing

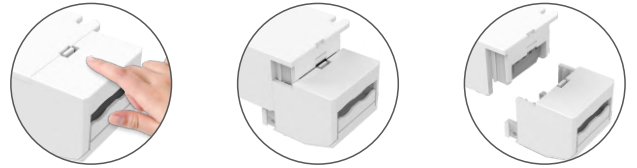

Pull the housing left and right from the bottom to remove it.

DMX Address Settings

The DMX driver can work with a DMX address programmer that follows the standard RDM protocol. It is recommended to use LTECH RDM Programmer (Model: WiFi-RDM01), which allows remote browsing, parameter setting, checking output power and modifying the current value.

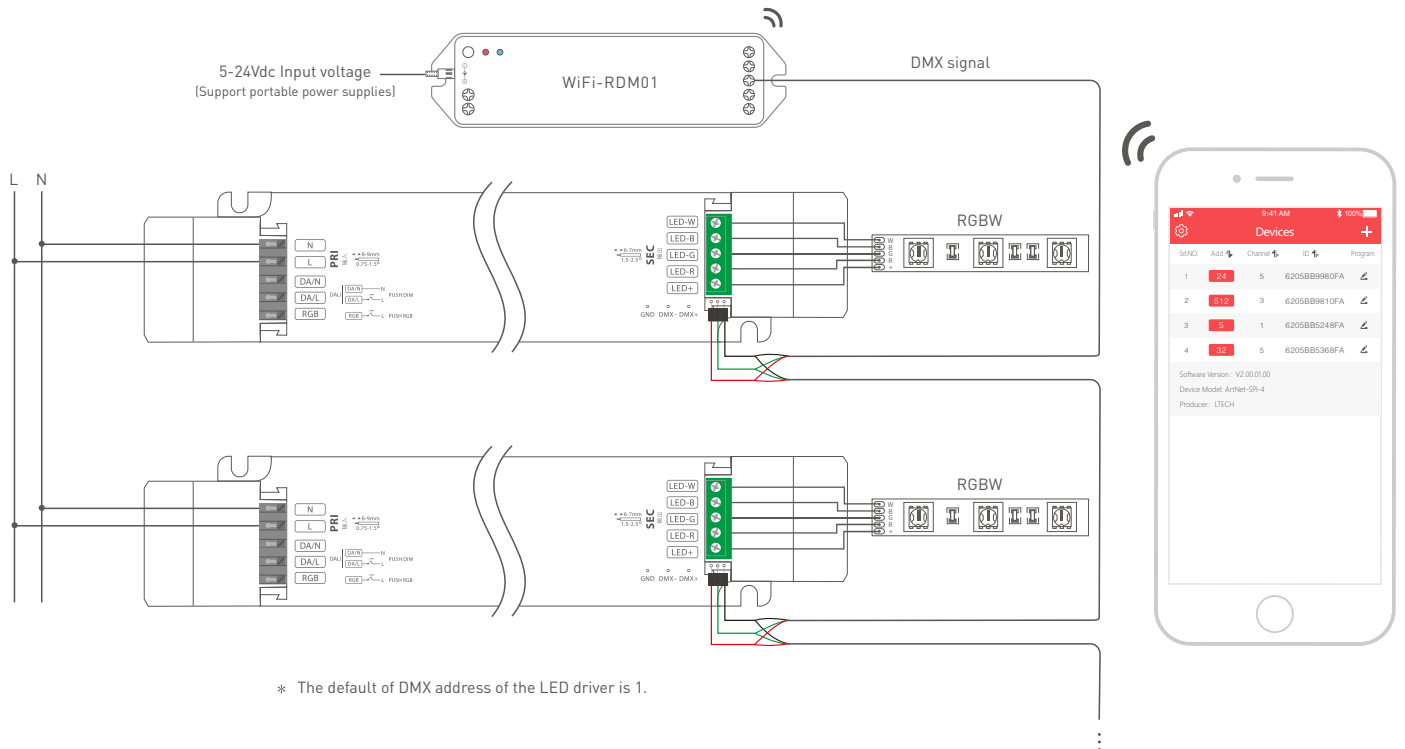

Mobile App Interface for the RDM Programmer

Download the App with your mobile phone and connect the RDM Programmer successfully, then you are allowed to set parameters through the APP. Please refer to the WiFi-RDM01 manual for more details.

- At the homepage, click "Add" of the device you are going to operate to edit the address, as shown below in the interface.
- Click "ID" to get more details for devices.
- Click "No" to issue a recognizing command.
- Click "⚙️" to view/modify parameters, including modifying frequency, mode, curve, querying output power and modifying current.
- Click "⚙️" in the upper left corner to access the settings which allows you to test, edit DMX addresses, set WiFi for devices and upgrade firmware.

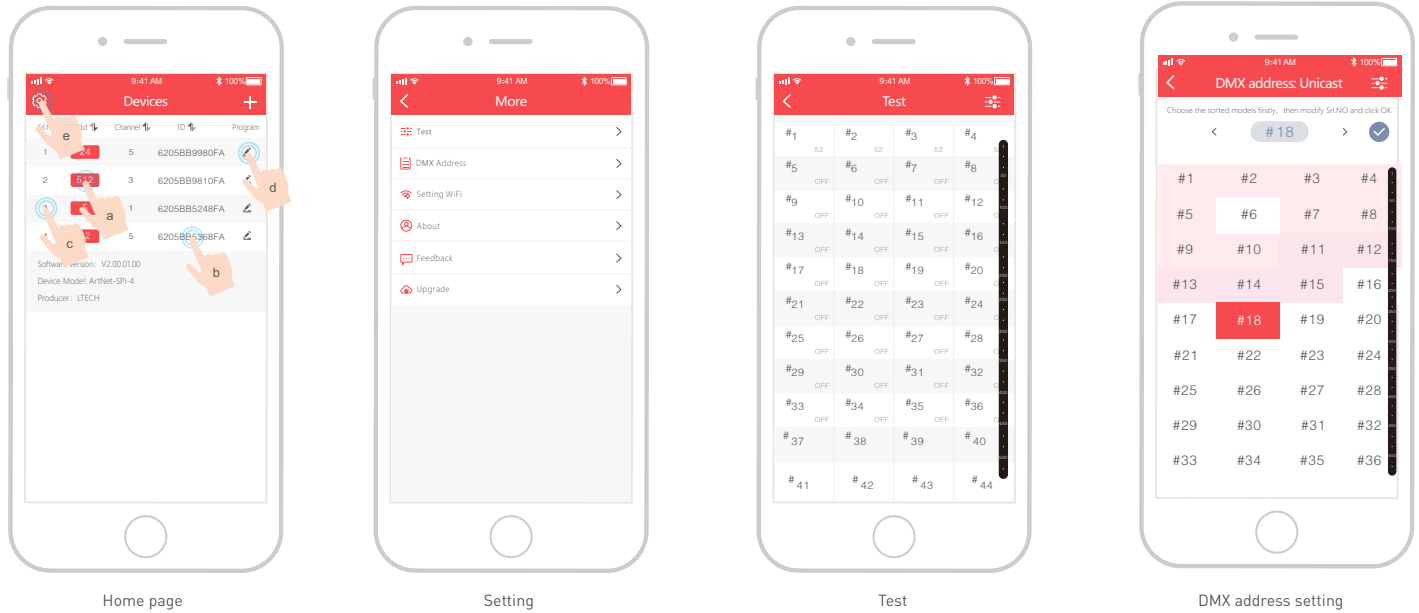

Relationship Diagrams

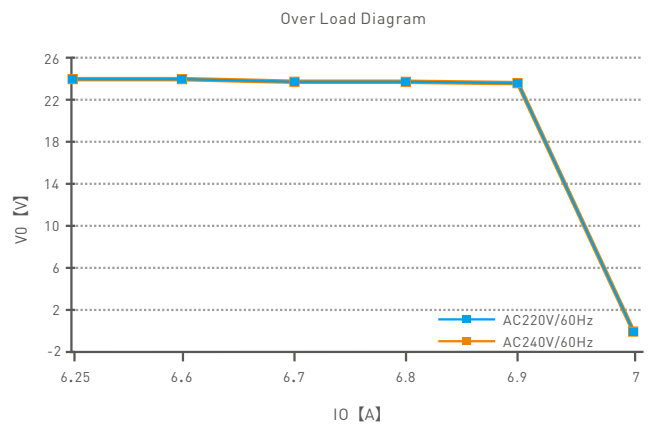
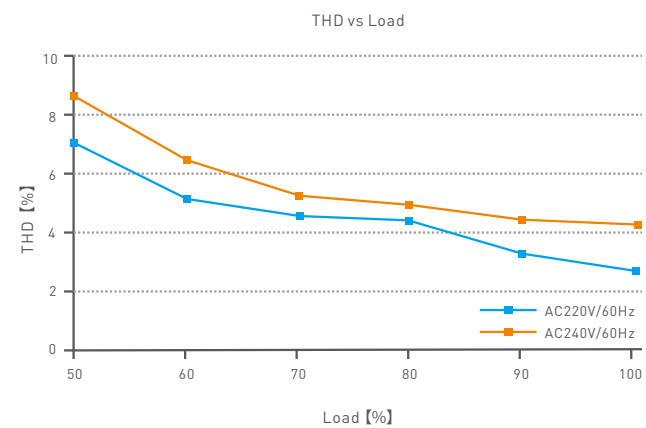
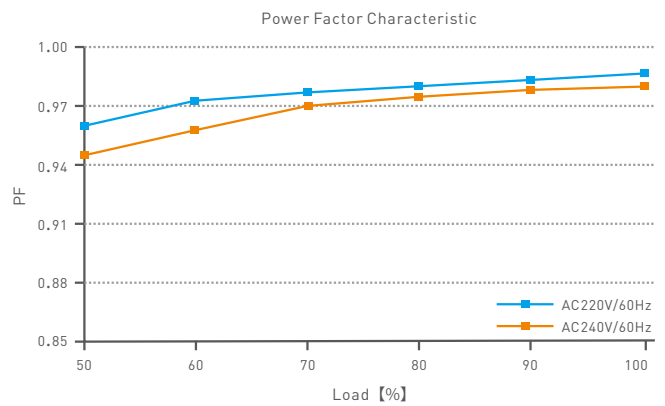
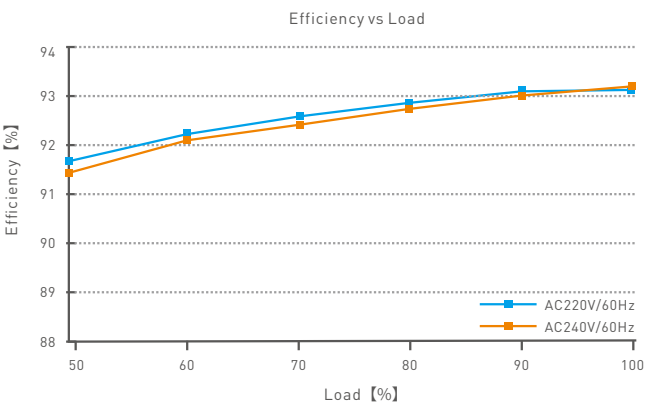

Flicker Test Table

IEEE 1789

Limit value of Modulation in Low Risk Areas	
Waveform frequency of Optical output (f)	Limit value (%)
$f \leq 8\text{Hz}$	0.2
$8\text{Hz} < f \leq 90\text{Hz}$	$0.025 \times f$
$90\text{Hz} < f \leq 1250\text{Hz}$	$0.08 \times f$
$f > 1250\text{Hz}$	Exemption assessment
Limit value of Modulation in No Effect Areas	
Waveform frequency of Optical output (f)	Limit value (%)
$f \leq 10\text{Hz}$	0.1
$10\text{Hz} < f \leq 90\text{Hz}$	$0.01 \times f$
$90\text{Hz} < f \leq 3125\text{Hz}$	$(0.08/2.5) \times f$
$f > 3125\text{Hz}$	Exemption assessment (High frequency exemption)

Brightness

- ▲ 0.1%
- ◆ 1%
- ▲ 5%
- ◆ 10%
- 20%
- ▲ 30%
- 40%
- ★ 50%
- 60%
- 70%
- ★ 80%
- ★ 90%
- ◆ 100%

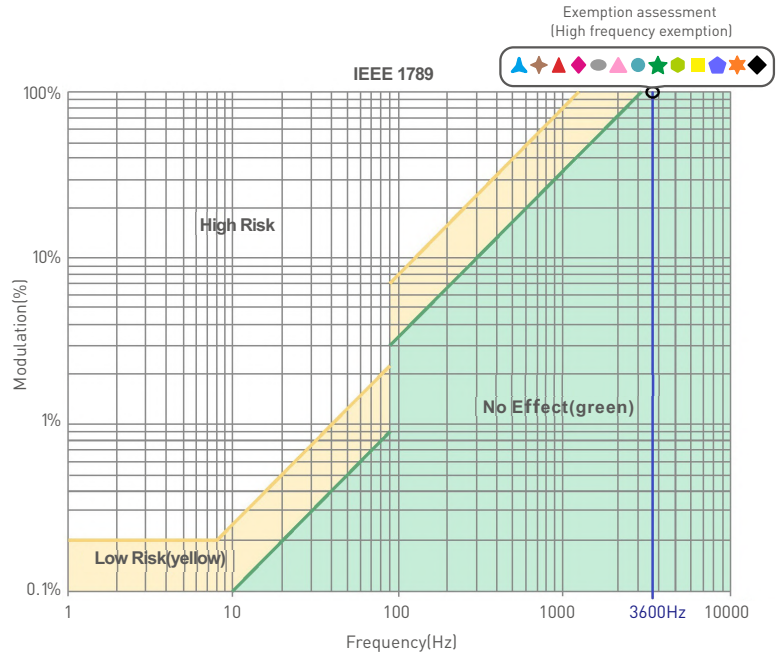

Marks in the right chart are tested results of different current levels. The output frequency is 0Hz in 100% brightness and its corresponding modulation is 0%, which could not be shown in the right chart.

Packaging Specifications

Model	LM-150-24-G4K3
Carton Dimensions	370x340x93mm(LxWxH)
Quantity	10 PCS/Layer; 2 Layers/Carton; 20 PCS/Carton
Weight	0.43 kg/PC; 9.4 kg/Carton

Packaging Image

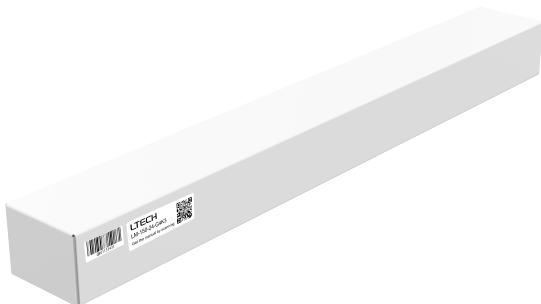

Inner Packaging Box



Carton Packaging

Transportation and Storage

1. Transportation

Products can be shipped via vehicles, boats and planes.

During transportation, products should be protected from rain and sun. Please avoid severe shock and vibration during the loading and unloading process.

2. Storage

The storage conditions should comply with the Class I Environmental Standards. The products that have been stored for more than six months are recommended to be re-inspected and can be used only after they have been qualified.

Attentions

- Products shall be installed by qualified professionals.
- LTECH products are non-waterproof (special models excepted). Please avoid the sun and rain. When installed outdoors, please ensure it is mounted in a water proof enclosure.
- Good heat dissipation will extend the working life of products. Please ensure good ventilation.
- Please check if the working voltage used complies with the parameter requirements of products.
- The diameter of wire used must be able to load the light fixtures you connect and ensure the firm wiring.
- Before you power on products, please make sure all the wiring is correct in case of incorrect connection that causes damage to light fixtures.
- If a fault occurs, please do not attempt to fix products by yourself. If you have any question, please contact your suppliers.

* This manual is subject to changes without further notice. Product functions depend on the goods. Please feel free to contact our official distributors if you have any question.

Warranty Agreement

- Warranty periods from the date of delivery: 5 years.
- Free repair or replacement services for quality problems are provided within warranty periods.

Warranty exclusions below:

- Beyond warranty periods.
- Any artificial damage caused by high voltage, overload, or improper operations.
- Products with severe physical damage.
- Damage caused by natural disasters and force majeure.
- Warranty labels and barcodes have been damaged.
- No any contract signed by LTECH.

1. Repair or replacement provided is the only remedy for customers. LTECH is not liable for any incidental or consequential damage unless it is within the law.
2. LTECH has the right to amend or adjust the terms of this warranty, and release in written form shall prevail.

Update Log

Version	Updated Time	Update Content	Updated by
A0	2021.08.05	Original version	Liu Weili