

PHILIPS

Fortimo

LED

Fortimo SLM C 1319 L23
2828 G8 UHE

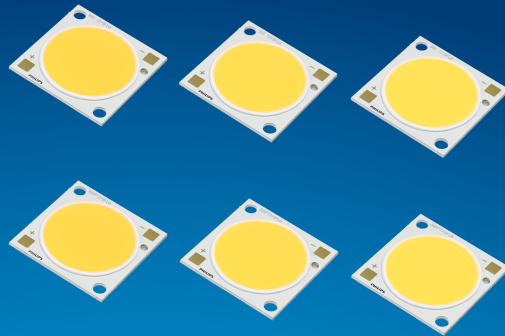

Datasheet

200lm/W chip-on-board that makes sense!

Fortimo SLM C 1319 L23 2828 G8 UHE

200lm/W claims are not new in the market for COB. While such claims, at a closer look, are either at very low temperature like 25°C, or at very low driving current and flux output, which doesn't make sense to real applications like retail. To further build on the success of Fortimo SLM G7 HE and HE+ which is well recognized by the market, PHILIPS Fortimo SLM G8 UHE offers first-of-its-kind 200lm/W at 2000lm from LES 15mm and 4000lm from LES 23mm, at tc temperature of 50°C, which meets the actual application requirements.

Key features and benefits

Specially engineered chip for optimal quantum efficiency at low driving current (contributing to the high efficacy)
Further optimized phosphor recipe based on HE+ technology for even higher efficacy without sacrificing QoL and Reliability
Lower thermal resistance to enable lower operating temperature (better performance) or luminaire miniaturization
Same footprint as Fortimo G7 (L15 2024 and L23 2828), ensuring compatibility with existing holders and optics
Optimized string configuration for higher system efficiency together with the existing PHILIPS indoor point drivers
Available in both standard color and Premium White

January 2024



Ordering data

Commercial product name	EOC	12NC	EPREL registration #	Box quantity
Fortimo SLM C 940 1319 L23 2828 G8 UHE	8720169 325371 00	9290 038 73580	1865328	10
Fortimo SLM C 935 1319 L23 2828 G8 UHE	8720169 325340 00	9290 038 73480	1865326	10
Fortimo SLM C 930 1319 L23 2828 G8 UHE	8720169 325319 00	9290 038 73380	1865327	10
Fortimo SLM C 940 PW 1319 L23 2828 G8 UHE	8720169 325463 00	9290 038 73880	1865330	10
Fortimo SLM C 935 PW 1319 L23 2828 G8 UHE	8720169 325432 00	9290 038 73780	1865331	10
Fortimo SLM C 930 PW 1319 L23 2828 G8 UHE	8720169 325401 00	9290 038 73680	1865323	10

Drive currents

Parameter	Nominal*	Life**	Max***	Unit
Fortimo SLM C 1319 L23 2828 G8 UHE	600	1200	1200	mA

Module temperatures

Parameter	Nominal*	Life**	Max***	Unit
T _c (case temperature at T _c point)	50	85	85	°C

* Nominal value at which typical performance is specified

** Value at which life time is specified

*** Maximum value for safe operation, do not operate above this value

Optical characteristics - table per color (CCT)

Fortimo SLM C 940 1319 L23 2828 G8 UHE

Parameter	Min	Typ	Max	Unit
Luminous flux	4028	4240	4664	lm
Efficacy		202		lm/W
Correlated color temperature (CCT)		4000		K
Color coordinates (CIEx, CIEy)		(0.382, 0.380)		-
Color consistency			2	SDCM
CRI	90			
R9	50			
Photometric code		940/259		
Photobiological safety			RG1 unlimited	



Measurement precision $\pm 5\%$ for the flux data and $\pm 6\%$ for the efficacy data. Measurement precision for color coordinates ± 0.005 . Measurement precision for CRI ± 1.5 .

Operation point	940	lm	lm/W
80% I-nom 480mA	Tc 25 °C	3524	211
	Tc-nom 50 °C	3397	205
	Tc-max 85 °C	3209	196
I-nom 600mA	Tc 25 °C	4399	208
	Tc-nom 50 °C	4240	202
	Tc-max 85 °C	4009	194
I-max 1200mA	Tc 25 °C	8671	197
	Tc-nom 50 °C	8365	191
	Tc-max 85 °C	7914	183

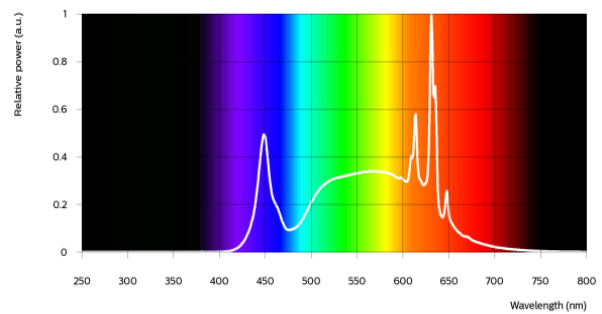

Fortimo SLM C 935 1319 L23 2828 G8 UHE

Parameter	Min	Typ	Max	Unit
Luminous flux	3990	4200	4620	lm
Efficacy		201		lm/W
Correlated color temperature (CCT)		3500		K
Color coordinates (CIEx, CIEy)		(0.407, 0.392)		-
Color consistency			2	SDCM
CRI	90			
R9	50			
Photometric code		935/259		
Photobiological safety			RG1 unlimited	



Measurement precision $\pm 5\%$ for the flux data and $\pm 6\%$ for the efficacy data. Measurement precision for color coordinates ± 0.005 . Measurement precision for CRI ± 1.5 .

Operation point	935	lm	lm/W
80% I-nom 480mA	Tc 25 °C	3490	209
	Tc-nom 50 °C	3365	203
	Tc-max 85 °C	3179	194
I-nom 600mA	Tc 25 °C	4357	206
	Tc-nom 50 °C	4200	201
	Tc-max 85 °C	3971	192
I-max 1200mA	Tc 25 °C	8590	195
	Tc-nom 50 °C	8286	190
	Tc-max 85 °C	7839	182

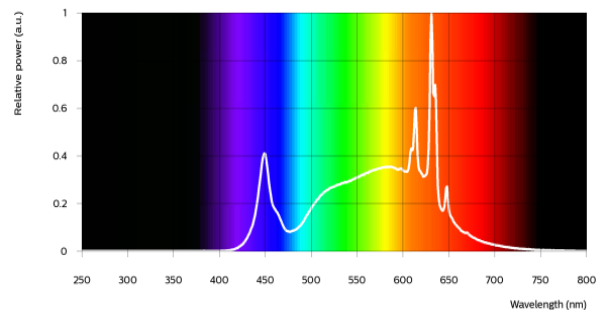

Fortimo SLM C 930 1319 L23 2828 G8 UHE

Parameter	Min	Typ	Max	Unit
Luminous flux	3866	4070	4477	lm
Efficacy		194		lm/W
Correlated color temperature (CCT)		3000		K
Color coordinates (CIEx, CIEy)		(0.434, 0.403)		-
Color consistency			2	SDCM
CRI	90			
R9	50			
Photometric code		930/259		
Photobiological safety			RG1 unlimited	

Measurement precision ± 5% for the flux data and ± 6% for the efficacy data. Measurement precision for color coordinates ± 0.005. Measurement precision for CRI ± 1.5.

Operation point	930	lm	lm/W
80% I-nom 480mA	Tc 25 °C	3382	202
	Tc-nom 50 °C	3260	197
	Tc-max 85 °C	3080	188
I-nom 600mA	Tc 25 °C	4221	200
	Tc-nom 50 °C	4070	194
	Tc-max 85 °C	3848	186
I-max 1200mA	Tc 25 °C	8322	189
	Tc-nom 50 °C	8028	184
	Tc-max 85 °C	7595	176

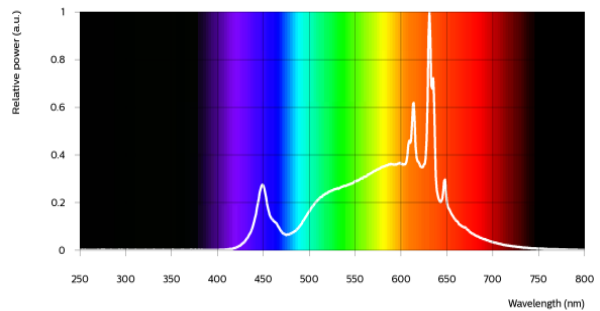

Fortimo SLM C 940 PW 1319 L23 2828 G8 UHE

Parameter	Min	Typ	Max	Unit
Luminous flux	3924	4130	4543	lm
Efficacy		197		lm/W
Correlated color temperature (CCT)		4000		K
Color coordinates (CIEx, CIEy)		(0.374, 0.364)		-
Color consistency			2	SDCM
CRI	90			
R9	50			
Photometric code		940/259		
Photobiological safety			RG1 unlimited	

Measurement precision ± 5% for the flux data and ± 6% for the efficacy data. Measurement precision for color coordinates ± 0.005. Measurement precision for CRI ± 1.5.

Operation point	940	lm	lm/W
80% I-nom 480mA	Tc 25 °C	3434	205
	Tc-nom 50 °C	3310	200
	Tc-max 85 °C	3127	191
I-nom 600mA	Tc 25 °C	4287	203
	Tc-nom 50 °C	4130	197
	Tc-max 85 °C	3907	189
I-max 1200mA	Tc 25 °C	8451	192
	Tc-nom 50 °C	8152	186
	Tc-max 85 °C	7713	179

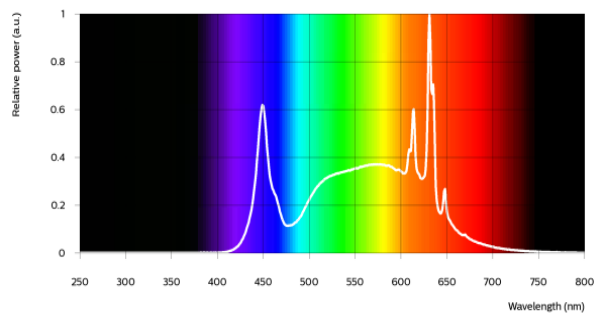

Fortimo SLM C 935 PW 1319 L23 2828 G8 UHE

Parameter	Min	Typ	Max	Unit
Luminous flux	3886	4090	4499	lm
Efficacy		195		lm/W
Correlated color temperature (CCT)		3500		K
Color coordinates (CIEx, CIEy)		(0.398, 0.376)		-
Color consistency			2	SDCM
CRI	90			
R9	50			
Photometric code			935/259	
Photobiological safety				RG1 unlimited

Measurement precision ± 5% for the flux data and ± 6% for the efficacy data. Measurement precision for color coordinates ± 0.005. Measurement precision for CRI ± 1.5.

Operation point	935	lm	lm/W
80% I-nom 480mA	Tc 25 °C	3399	203
	Tc-nom 50 °C	3276	198
	Tc-max 85 °C	3096	189
I-nom 600mA	Tc 25 °C	4243	201
	Tc-nom 50 °C	4090	195
	Tc-max 85 °C	3867	187
I-max 1200mA	Tc 25 °C	8364	190
	Tc-nom 50 °C	8069	185
	Tc-max 85 °C	7634	177

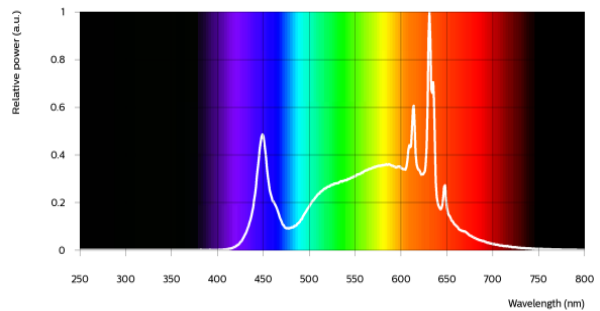

Fortimo SLM C 930 PW 1319 L23 2828 G8 UHE

Parameter	Min	Typ	Max	Unit
Luminous flux	3848	4050	4455	lm
Efficacy		193		lm/W
Correlated color temperature (CCT)		3000		K
Color coordinates (CIEx, CIEy)		(0.422, 0.386)		-
Color consistency			2	SDCM
CRI	90			
R9	50			
Photometric code			930/259	
Photobiological safety				RG1 unlimited

Measurement precision ± 5% for the flux data and ± 6% for the efficacy data. Measurement precision for color coordinates ± 0.005. Measurement precision for CRI ± 1.5.

Operation point	930	lm	lm/W
80% I-nom 480mA	Tc 25 °C	3364	201
	Tc-nom 50 °C	3243	196
	Tc-max 85 °C	3064	187
I-nom 600mA	Tc 25 °C	4200	199
	Tc-nom 50 °C	4050	193
	Tc-max 85 °C	3828	185
I-max 1200mA	Tc 25 °C	8279	188
	Tc-nom 50 °C	7986	183
	Tc-max 85 °C	7555	175

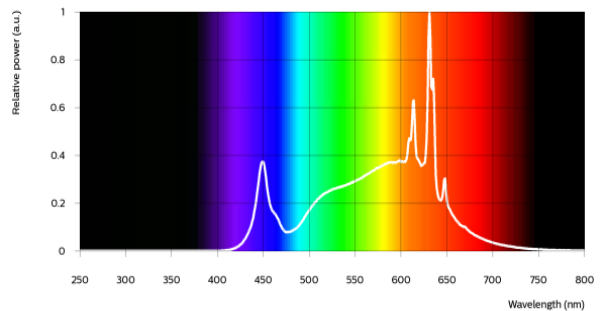

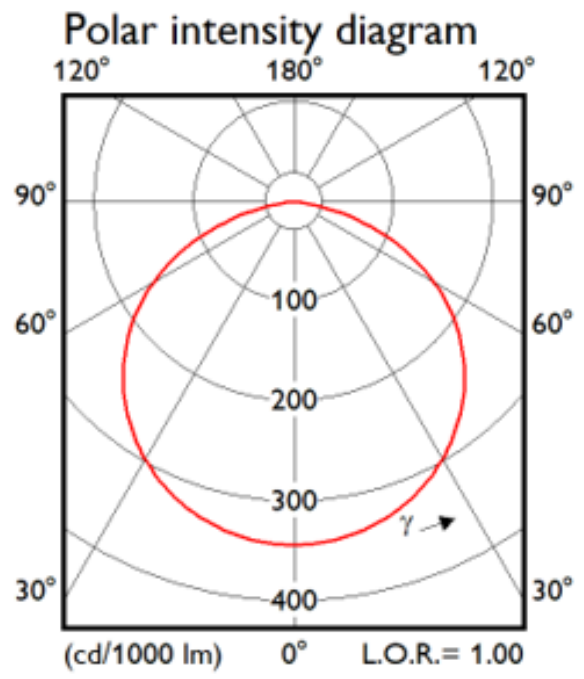

Electrical characteristics

Parameter	Min	Typ	Max	Unit
Forward voltage	33.0	34.9	37.0	V
Power consumption	19.8	20.9	22.2	W = kWh/1000h
Number of modules in series per chain			1	
Number of modules per chain			1	
Number of modules in parallel			1	

Measurement precision for Vf +/- 3%. Measurement precision for power +/- 3.3%

Tuning information

Flux and efficacy versus current (at Tc nominal)

I [mA]	Flux [%]	Efficacy [%]
1200	197	94
900	149	97
600	100	100
480	80	101
300	50	102

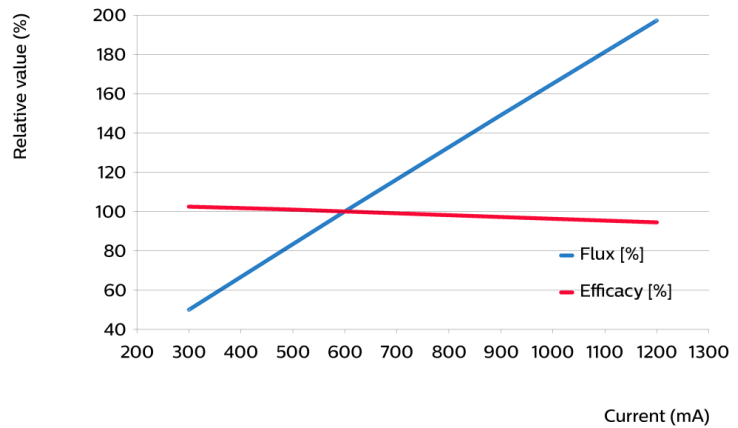

Flux and efficacy versus temperature at Tc (at I nominal)

Tc [°C]	Flux [%]	Efficacy [%]
85	95	96
50	100	100
25	104	103
0	107	105

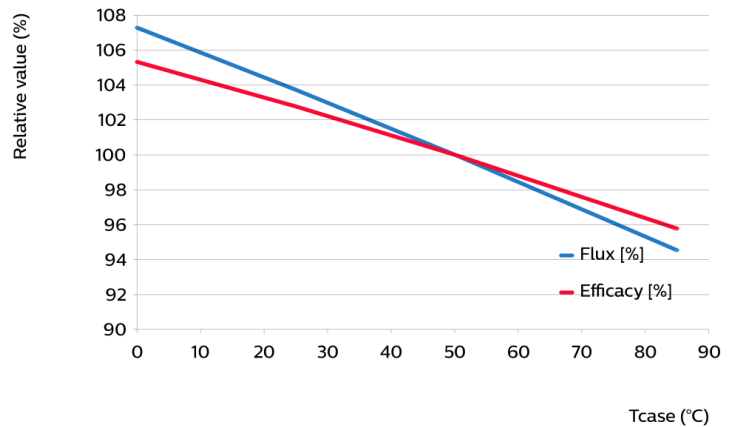

Lumen maintenance

Operation point	Lumen maintenance x 1000 hours	L70			L80			L90		
		B50	B20	B10	B50	B20	B10	B50	B20	B10
80% I-nom 480mA	Tc 50°C	>110	>110	>110	>110	>110	>110	>110	107	98
	Tc 65°C	>110	>110	>110	>110	>110	>110	108	91	84
	Tc 85°C	>110	>110	>110	>110	>110	>110	89	75	69
I-nom 600mA	Tc 50°C	>110	>110	>110	>110	>110	>110	>110	102	94
	Tc 65°C	>110	>110	>110	>110	>110	>110	103	87	80
	Tc 85°C	>110	>110	>110	>110	>110	>110	85	72	66
I-max 1200mA	Tc 50°C	>110	>110	>110	>110	>110	>110	105	89	82
	Tc 65°C	>110	>110	>110	>110	>110	>110	90	76	70
	Tc 85°C	>110	>110	>110	>110	>110	>110	74	63	57

Lifetime

Parameter	Value	Unit
M70F50 nominal	>110000	hours

Performance Window

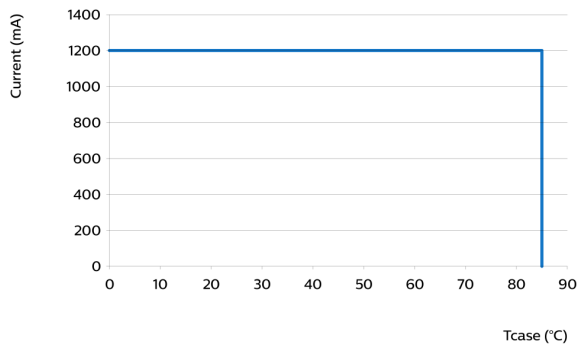

Mechanical characteristics

Parameter	Min	Typ	Max	Unit
Length	27.8	28	28.2	mm
Width	27.8	28	28.2	mm
Height	0.9	1	1.1	mm
Height	1.5	1.7	1.9	mm
Product mass		2.28		gram

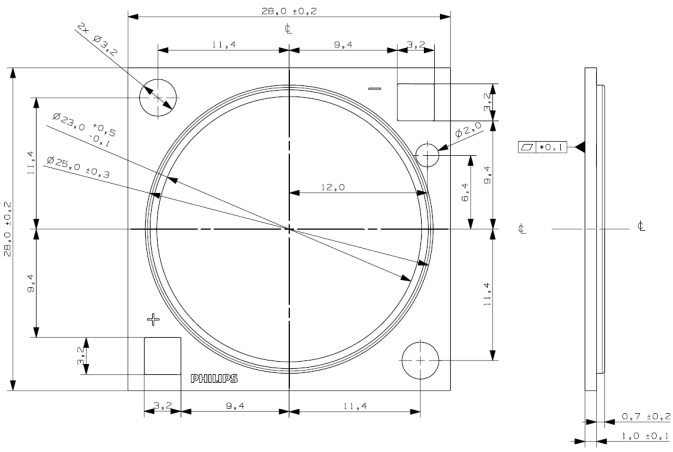

Absolute ratings

Parameter	Min	Max	Unit
Current through the LED module (I-max)		1200	mA
Case temperature (Tc-max)		85	°C
ESD (direct contact)	8		kV
Working voltage		60	V _{dc}
Ambient temperature	-20	40	°C
Storage temperature	-40	80	°C

Application information

Certificates and Standards

CB
 CE
 ENEC
 ENEC+
 EPRS 001
 IEC/EN 62031
 UKCA
 UL
 UL 8750

Environmental

RoHS/REACH

Application

Dimming	Yes
---------	-----



© 2024 Signify Holding, IBRS 10461, 5600VB, NL. All rights reserved. The information provided herein is subject to change, without notice. Signify does not give any representation or warranty as to the accuracy or completeness of the information included herein and shall not be liable for any action in reliance thereon. The information presented in this document is not intended as any commercial offer and does not form part of any quotation or contract, unless otherwise agreed by Signify.

www.philips.com/oem

Philips and the Philips Shield Emblem are registered trademarks of Koninklijke Philips N.V. All other trademarks are owned by Signify Holding or their respective owners.
UK importer address: Signify Commercial UK Limited, 3 Guildford Business Park, GU2 8XG

12/01/2024